



# HORWIN EK3 USER MANUAL



# EK3 User Manual

Welcome to join HORWIN family! We will guide you to understand every function of EK3 electric motorcycle and use EK3 electric motorcycle correctly and safely. To ensure your safety, please read this manual carefully before riding and ensure that you always comply with the following requirements:

Fully understand information in this manual, including but not limited to relevant instructions, precautions and warning information.

Fully understand the operation and emergency measures for EK3 electric motorcycle.

Pay attention to warning labels of EK3 electric motorcycle.

HORWIN will not assume any responsibility arising from unauthorized modification, failure to use original accessories, or installation of components that affect the performance and safety of the motorcycle.

Please contact HORWIN Customer Service Center at Email: [service@horwinglobal.com](mailto:service@horwinglobal.com)

Should you have any problem on this motorcycle. we will always at your service. Wish you a safe and happy journey!

# Safety Instructions

Please read this product manual carefully, and please do not use this product until you have known the characteristics of the electric two-wheeled motorcycle.

Please abide by traffic rules, do not retrograde or run red lights and do not use mobile phone while riding the motorcycle.

Please don't use third-party accessories or disassemble, crack and modify the motorcycle without authorization, otherwise the losses arising therefrom will be borne by you, and you will lose the right to enjoy our warranty service.

Due to the continuous improvement of the product, the vehicle you purchased may be slightly different from the vehicle described in this manual, and the actual motorcycle shall prevail. If you are unclear about the use, repair and installation of this vehicle, please contact our dealer.



For the safety of you and others, please read the following instructions carefully:

The rider should abide by traffic rules and pay attention to the traffic safety.

Before riding the motorcycle, please carefully read the Product Manual and carefully check whether all parts are in good condition, so as to guarantee the traffic safety. If any problems are found, please contact the dealer in time.

To ensure your safety, please wear safety helmet, gloves and other protective equipment when driving motorcycles. Please don't wear loose clothes, otherwise you will be uncomfortable and unsafe when driving the motorcycle.

Please make sure that you are in good health and not tired, so that you can control the vehicle in a good state. Please don't ride the motorcycle after taking drugs, medicines and drinking alcohol.

This motorcycle can resist rain and snow, but can't excessively wade into the water. When the water level exceeds 20 cm, if the motorcycle wades into water, all electrical components and lines may be short-circuited!

Please obey the traffic rules, and slow down the electric motorcycle when the weather is rainy or snowy or the road is slippery. When braking the motorcycle, the braking distance should be increased to ensure safety.

Please do not disassemble the components and parts by yourself.

Do not park the electric motorcycle on the hall, escape stair, passageway or safety exit;

Please do not charge or park the electric motorcycle in the residential building. When charging an electric motorcycle, the electric motorcycle should be kept away from combustibles and the charging time should not be too long.

## **Product Overview**

Thank you for purchasing the EK3 electric two-wheeled motorcycle, which is hereinafter referred to as EK3.

Schematic Diagram of Body and Components:

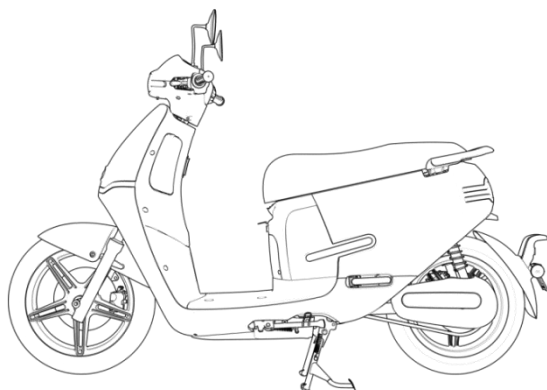

## Description of Parts

Left Side

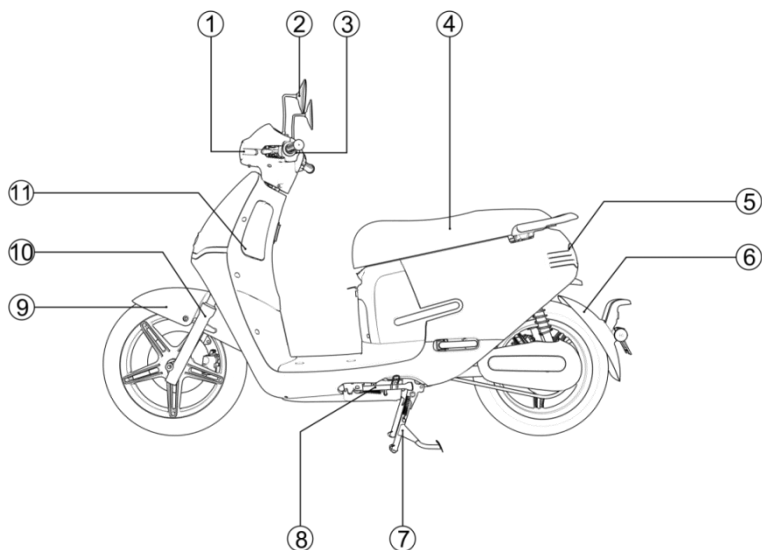

- ① Headlamp    ② Rearview mirror    ③ Left combination switch  
④ Saddle    ⑤ Tail lamp    ⑥ Rear fender    ⑦ Middle stand  
⑧ Side stand    ⑨ Front fender    ⑩ Front shock absorber  
⑪ Storage box (inbuilt USB)

## Right Side

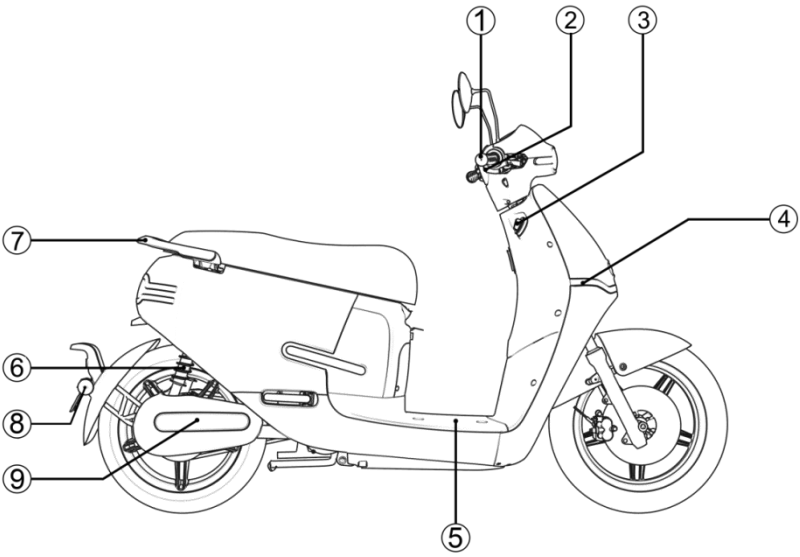

- ①Throttle    ②Right combination switch    ③Ignition lock
- ④Steering lamp    ⑤Footboard    ⑥Rear shock absorber
- ⑦Rear armrest    ⑧Reflector    ⑨Rear fork decorative cover

## Instrument and Combination Switch

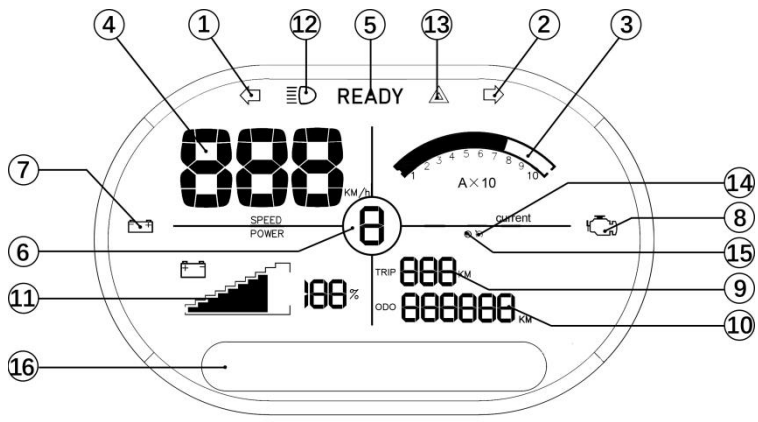

### 1. Left turn signal

Turn on the left turn signal lamp, the indicator flashes.

### 2. Right turn signal

Turn on the right turn signal lamp, the indicator flashes.

### 3. Current display bar

Display the current real-time current of the controller.

### 4. Speed per hour

Display current speed.

### 5. Parking light

Indicates that the vehicle has entered a state ready to ride. Rotate the speed control handle to move the vehicle forward.

### 6. Gear display

Display the current gear

The top speed in the first gear is 45KM/H

The top speed in the second gear is 75KM/H

The top speed in the third gear is 95KM/H

### 7. Low battery indicator

When the power is less than 20%, the indicator lights up

## 8. OBD icon

When a fault occurs, this icon will light up

## 9. Single mileage

Display the single mileage

## 10. Total mileage

Display the total mileage

## 11. Battery Indicator

Display the current battery status in percentage, up to 100%.

## 12. High beam

The indicator will light up when the high beam is turned on.

## 13. Double flashing indicator

Press the double-flash switch, then the left and right turn signals will light up and the icon will light up.

## 14. Cruise Control

The vehicle keeps running at the current speed. After pressing the cruise control button or accelerating/braking the motorcycle, the cruise control state can be released.





## 15. Reverse Display



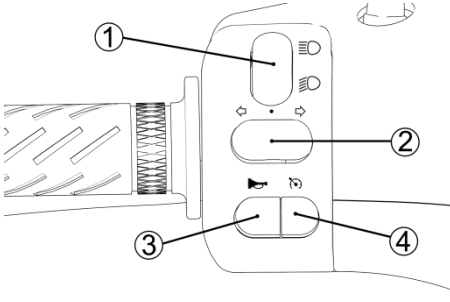
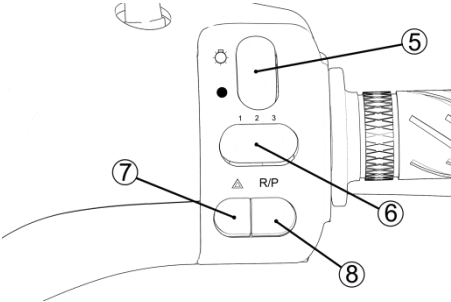

Press and hold the reverse button, the vehicle enters reverse mode. Then turn the throttle, the vehicle goes backward.

## 16. Sliding Screen

When the distance between the electronic key and the vehicle is less than 1.2 meters, swipe the screen to the right, start the motorcycle, swipe the screen to the left and stop the motorcycle.

## Schematic Diagram of Combination Switch

	
<p>  Hand combination switch</p> <p>① High/low beam</p> <p>Turn the switch upward, the light is high beam; Turn the switch downward, the light is low beam</p>	<p> Hand combination switch</p> <p>● Motorcycle lamp switch</p> <p>⑤ Motorcycle lamp switch</p> <p>Turn the button to the lower side, all the lamps are turned off</p> <p>Turn the button to the upper side, the headlamp is turned on.</p>

 <p>②Steering lamp</p> <p>Turn the switch to the left to turn on the left turn signal;</p> <p>Turn the switch to the left to turn on the left turn signal;</p> <p>Turn the switch to the middle position to reset the switch, and turn off the left/right turn signal.</p>	 <p>⑥Gear mode</p> <p>Press the left, middle and right buttons to adjust the gear</p>
 <p>③Horn</p> <p>After pressing the horn button, the horn rings; after releasing the horn button, the horn stops ringing.</p>	 <p>⑦Warning Lamp(double flash)</p> <p>Press the button, then the left and right turn signals flash</p>
 <p>④Cruise Control</p> <p>Press the button to keep the motorcycle running at the current speed</p> <p>To release this state, press this button again or accelerate/brake the motorcycle.</p>	<p>⑧Start\ reverse switch</p> <p>Click the button to enter the Ready state</p> <p>Press the button to enter the reverse mode, and release the button to enter the forward mode</p>

# Key and Remote Control

## Electronic Key



1. Anti-theft button: Press the button gently, then the vehicle will enter the anti-theft alarm state. When the electronic key is more than 1.2 meters away from the motorcycle, the motorcycle will automatically enter the anti-theft state.
2. Defense cancel button: slightly press to release the vehicle from anti-theft alarm state.
3. Startup button: double click; the vehicle can turn on the whole-vehicle power supply without key.

When using the electronic key, it is necessary to ensure that the battery is correctly installed inside the motorcycle, and the effective remote control distance shall be no more than 50M. When matching the electronic key with the motorcycle, the distance between the electronic key and the motorcycle should be less than 1.2m

# Mechanical Key

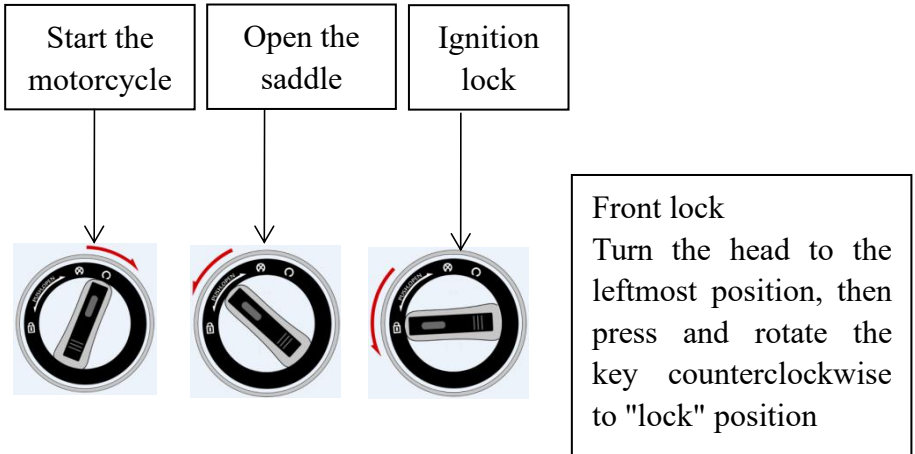
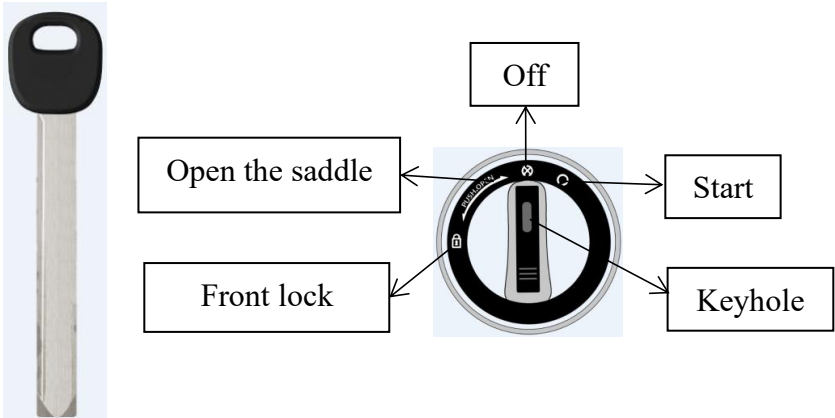

## Open the saddle

When the distance between the remote control key and motorcycle is less than 1.2m, Press inward with a "click" sound and loose the button, then turn the key left to "open" position to open the saddle.

Insert the mechanical key, turn it to "open" position, and open the saddle.

## Battery and Charger

### Battery Use Instructions

The vehicle has two charging modes: battery charging and body charging.

#### External charging mode

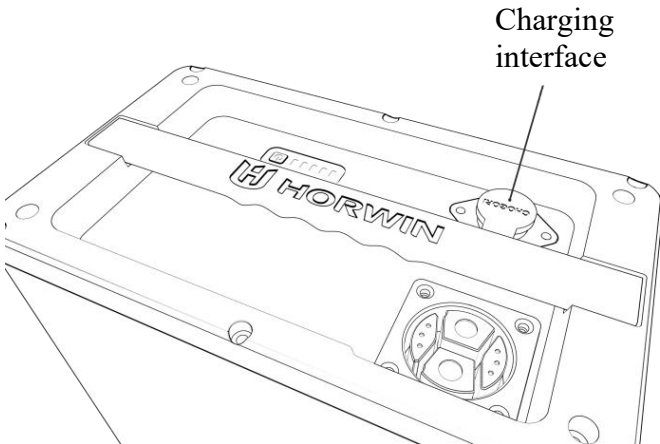

Take out the battery, plug the charger into the charging interface, then plug into the socket and press the battery start button. Then the power indicator will light up and display the real-time power.

### Vehicle Charging Mode

Put the battery into the battery compartment, connect the vehicle power plug to the battery, and then insert the charger charging plug into the charging interface above the footboard to charge the motorcycle. Then the charger indicator will light up and the battery will display the real-time power.

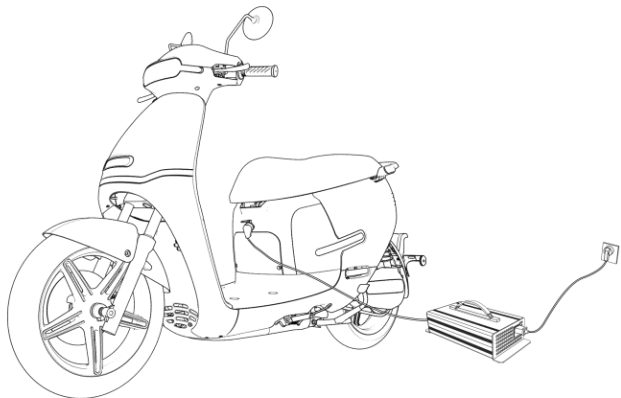

### Charging interface

#### Description of battery power indicator

In the charging state, the indicator light shows the battery power. After the battery is fully charged, all indicator lights are normally on and will no longer flash.

In the Non-Charging state, press the power display button:

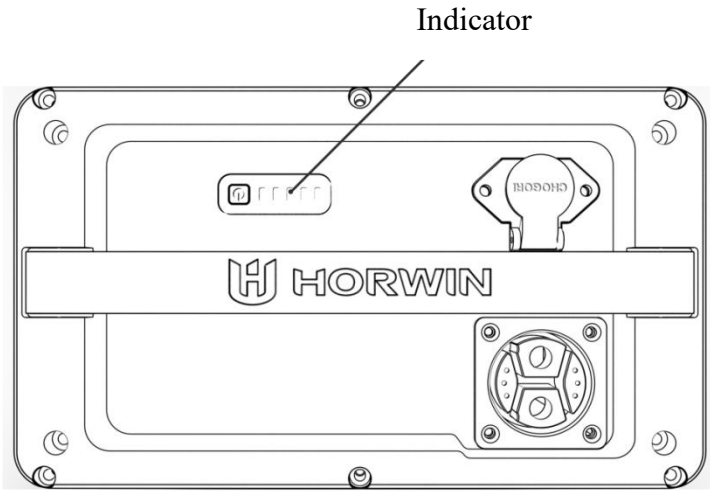

In the normal state, the indicator shows the battery power.

Each grid displays 20% of power.

### **Battery Manual**

Before using the battery, please make sure that the battery is the original battery, and do not use other brand or type of battery.





Check whether the appearance of the battery is intact, and ensure that there are no obvious phenomena such as damage, liquid leakage, overheat, water immersion and smoke.

In order to ensure transportation safety, the power of the battery when leaving the factory is about 50% (when transported by air, the power

of the battery leaving the factory is about 30%). Due to self-consumption factors such as transportation cycle and storage cycle, when using the battery for the first time, the battery will have low or no power, which is a normal phenomenon. Please don't worry, just charge it according to the charging instructions.

Waste batteries shall not be dismantled without authorization, and shall be recycled by relevant professional department.

**Use Environment**



			
<p>Please use the battery at -10°C-45°C</p>	<p>Please avoid the battery being soaked by liquid such as water, beverage and corrosive liquid</p>	<p>Please avoid keeping the battery close to heat source, open flame and inflammable and explosive gas (liquid)</p>	<p>Please avoid metallic foreign body from entering the battery box</p>

At low temperature, the available capacity of the battery will decline in different degrees. For example: the available capacity is 70% at -10°C, 85% at 0°C and 100% at 25°C.

In case of abnormal conditions such as peculiar smell, overheat and deformation, please stop using the battery immediately, stay away from the battery and contact the dealer.

The battery is not the component that can be repaired by the user. In case of abnormal phenomenon, please contact the dealer. If the battery is disassembled without permission, the user will not enjoy the three-guarantee service, and the battery may be heated, smoked, on fire or exploded.

### Charging Environment

		
<p>Please use the original charger to charge the battery, and do not use other brand or type of charger to charge the battery.</p>	<p>Please charge the battery at the ambient temperature of 0°C~35°C</p>	<p>Please do not charge the battery for more than 8 hours, otherwise the service life of the battery will be affected.</p>

- In the early stage, the charging speed is fast, and in the later stage, the charging speed is slow, which is because that the procedure is set for charging safety and belongs to the normal condition.
- In the winter, if the outdoor temperature is low and below 0°C, the charging will be suspended, which is a normal phenomenon. Please charge the battery at a suitable ambient temperature to ensure the charging effect.
- During charging, some aluminum shell chargers have the thermal effect, and the surface temperature is high, which is a normal phenomenon, so please feel free to use the charger. Please avoid children touching the charger.

## **Precautions for Charger Use**

- The charger can only be used indoor.
- It is strictly forbidden to charge the battery in a confined space or in the high temperature environment, and the battery shall not be placed in the seat bucket or tail box during charging.
- During charging, plug the battery, then connect the charger to the commercial power; After the battery is fully charged, cut off the commercial power and then unplug the battery.
- When the green light is on, please cut off the power in time. It's forbidden to connect the charger to the AC power for a long time when the battery is not being charged.
- In the charging process, if the indicator is abnormal, the charger has peculiar smell or the charger shell is overheated, please immediately stop charging the battery and repair or replace the charger.
- Please do not disassemble the charger or replace the components in the charger by yourself.
- When the charger is replaced, the new charger should match the battery model.

## **Storage Environment**

- If the battery is placed on the vehicle, the battery power will be consumed in real time due to the operation of the alarm system. After being placed on the vehicle for a period of time, the instrument shows that the electric quantity is reduced, and this is normal.
- Please store the battery in an environment at 0°C~25°C, and do not store the battery in the environment at the temperature higher

than 40°C, otherwise the capacity of the battery will be irreversibly attenuated.

- In winter, summer or other special circumstances, if the vehicle is not used for a long time, the battery must be taken out of the vehicle, stored separately, maintained and charged regularly, otherwise the battery may be completely drained and irreversibly damaged. With regard to such problems, the battery failure will not be covered under warranty.
- When the battery is stored for a long time, the most suitable battery power is 50%. If the battery power is lower than 10% or higher than 90%, the battery capacity will be irreversibly attenuated.
- With regard to the self-consumption protection mode when the lithium battery is stored safely, the technical standards are as follows:
  1. If the battery is not used for a long time, it can be stored on the vehicle (the battery plug is not unplugged) and the maximum safe storage period is 15 days, otherwise the battery feeding may be caused and the battery cannot be restored.
  2. If the battery is not used for a long time, the power is no less than 50% and the battery is stored separately and stored on the vehicle (the battery plug is unplugged), the maximum safe storage period shall be 2 months, otherwise the battery feeding may be caused and the battery cannot be restored.
- Please do not store the battery in a place with the falling risk, otherwise the battery will be damaged uncontrollably and the battery will be leaked, heated, smoked, on fire or exploded.

 Undervoltage and feeding of the battery caused by improper use will not be covered under warranty.

## Precautions for Battery Use:

- When using the battery for the first time, please drain the battery as much as possible, then fully charge it before formally using it, so as to ensure that the actual capacity of the battery is as accurate as the electric quantity displayed on the instrument.
  - In the later period, please keep the battery power at least 20% and charge the battery in time, so as to prolong the service life of the battery.
  - When riding a motorcycle normally, it is recommended to control the speed at the middle speed. When starting the motorcycle, please slowly operate the throttle handle and gradually accelerate the motorcycle, thus extending the battery life.
  - When the battery is used for many times, there will be a deviation between the actual capacity of the battery and the electric quantity displayed on the meter. Please charge and discharge the battery completely at regular intervals (no more than 3 months). The internal battery core and intelligent system can automatically calibrate the electric quantity of the battery, thus improving the experience effect.
  - It is recommended to check the power plug of the battery every two months, and confirm whether the contact reed has the phenomena such as carbon deposition and oxidation (blackening). In case of these phenomena, please contact the dealer for maintenance.
-  The battery shall not be caught in the rain or flushed by water, and shall not be soaked in water. If the vehicle wades into the water, the water level shall not exceed the height of the battery compartment, otherwise the water will enter into the battery and the battery will be short circuited, thus causing the permanent battery failure. In this case, it is forbidden to charge the whole vehicle or battery again, otherwise

the battery may be on fire, burned and exploded. Please transfer the battery to the dealer for maintenance immediately.

## **Riding Guide**

### **Precautions for Preparation**

Drinking is a direct cause of death in motorcycle driving. Every year, 50% of drivers die from driving after drinking. Do not drive after drinking

Before your first drive, we strongly request you to:

Read the user manual;

Confirm that you have fully understood all safety information;

Understand how all control accessories work;

Before your first drive, please confirm that you:

Are in good physical and psychological conditions;

Wear helmet (fasten connecting shackle of the helmet and the safety belt), glasses and other protective clothing;

Do not drive after drinking or taking medicines;

### **Protective Clothing**

For safety consideration, we strongly recommend that you always wear qualified helmet, glasses, boots, trousers and long sleeves or jackets when driving.

## **Warnings**

In a collision, not wearing a helmet may increase the risk of injury or death. Please make sure to wear helmet, glasses and other protective equipment at all times when driving.

## **Driver Training**

It's necessary to improve your driving skills. Even if you have the experience of riding other motorcycles before, you still need to take time to get familiar with the working principle and driving control of EK3. Please practice driving the motorcycle in a safe place until your skills are mature and you have got used to the size and weight of EK3.

We request all drivers to take driving courses certified by local government. New drivers should attend basic training, even experienced drivers can benefit from advanced courses.

## **Inspection before riding**

### **Cautions**

When inspecting EK3, should you find any damage or problem, please correct it or have it corrected with assistance from authorized dealer before riding.

Before riding the EK3 electric motorcycle, please check the following items to ensure your safety on road.

Whether the handle rotates stably and flexibly.

Can left/right handle switch work normally.

Can the speed control handle work normally.

Ensure normal pressure of tire. Suggested tire pressure: 27-33psi for front wheels and 30- 36psi for rear wheels.

Check the tire surface for fracture, damage, wear or foreign matter piercing or adhesion.

Whether the tread depth is sufficient ( $> 0.8\text{mm}$ ).

Is there any fault alarm lamp on the instrument panel on.

Is the battery fully charged.

Can the headlamp, tail lamp, stop lamp and turn signal lamps work normally.

Can the horn work normally.

Are rearview mirrors clean. Adjust them to proper angle.

Is the brake oil sufficient. Can handles and brake system work normally.

Should there be any abnormality or operation issue, please contact HORWIN customer service center.

Email: [service@horwinglobal.com](mailto:service@horwinglobal.com)

## **Restrictions and Guidelines on Roads**

### **General Information**

#### **Cautions**

Overloading or improper loading may lead to abnormal motorcycle operation, which may cause serious injury or death. Please follow all load limits and other loading information in this manual.

## **Loading Instructions**

The maximum capacity of EK3 is 284KG, including weight of driver and passenger(s), as well as all components of the vehicle body. Your EK3 shall be preferentially used for you and your passenger(s).

However, if you want to load more goods, we suggest to use saddle bag. Please check with your dealer about the correct loading method and capacity range of EK3. Improper loading may affect the stability and maneuverability of EK3. Even if your EK3 is correctly loaded, you should drive within safe speed range.

When loading goods, please following the following rules:

Check whether the two tires are properly charged;

If you change your normal load, you may need to adjust the way the goods are hung;

To prevent goods from loosening which may cause hidden danger, please ensure that all goods are firmly bound;

Lower the center of gravity of goods and make it as close as possible to your own center of gravity;

Distribute the weight of goods evenly on two sides of the vehicle body;

## **How to start the vehicle**

EK3 can be started in two ways: by mechanical key and remote controller;

First method: start the vehicle by using mechanical key:

Step 1 Please wear a safety helmet, sit on the vehicle, insert the key to rotate the ignition lock to the starting state, and then start the vehicle

Step 2 Please retract the side stand/middle stand, and press the "Start Switch",then the instrument displays "READY".

Step 3 Turn the throttle handle gentle and enjoy your first riding.

Second method: start the vehicle by using the electronic key:

Step 1 Please wear your safety helmet, sit on the vehicle, and the distance between the electronic key and the vehicle shall be less than 1.2m

Step 2 Please retract the side stand/middle stand, swipe the screen to the right, the vehicle is energized, press the "Start Switch", then the instrument displays "READY".

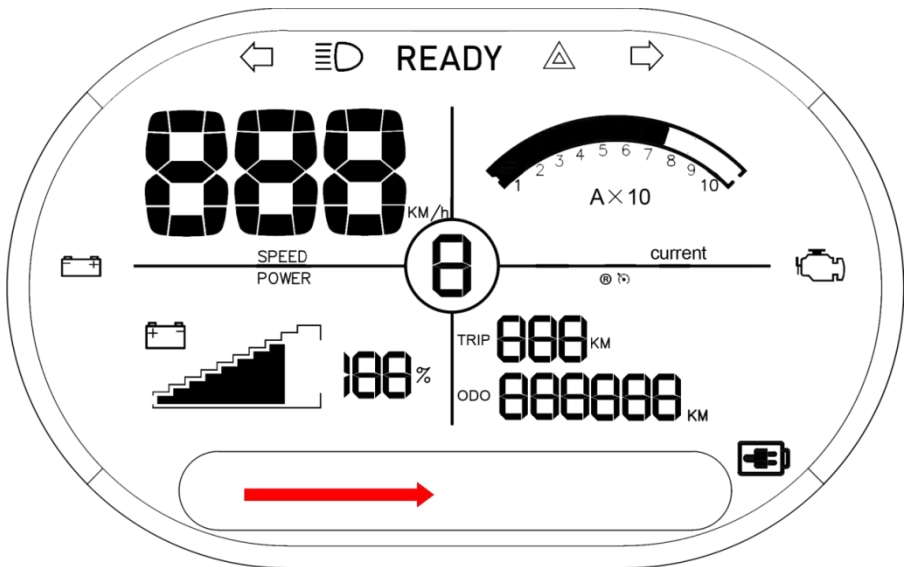

Step 3 Turn the throttle handle gentle and enjoy your first riding.

Third method: start the vehicle by using the electronic key:

Step 1 Please wear your safety helmet, sit on the vehicle, and the distance between the electronic key shall be less than 1.2m

Step 2 Please retract the side stand/middle stand, double click the Start Button on the electronic key at the interval of 0.5s, the vehicle is energized, press the "Start Switch", then the instrument displays "READY".

Step 3 Turn the throttle handle gentle and enjoy your first riding.

Fourth method: start the vehicle by using the electronic key:

Step 1 Please wear your safety helmet, sit on the vehicle, and the distance between the electronic key shall be less than 1.2m

Step 2 Please retract the side stand/middle stand, press the front lock, wait for 0.5s, the lamp on the lock lights up, rotate the key to the right, the vehicle is energized, press the "Start Switch", then the instrument displays "READY".

Step 3 Turn the throttle handle gentle and enjoy your first riding.

Before riding the vehicle, please check the vehicle components. If there is any abnormality, please repair the vehicle in time or ask the professional personnel to repair the vehicle.

## **Instructions for Braking**

- Before riding the vehicle, it is necessary to check whether the front and rear brake handles can work normally
- Excessive sudden braking may cause dead lock and slide of wheel, reducing control over the motorcycle. In this case, release the brake lever and continuously drive forward until the control restores, then brake more gently.
- Decelerate or completely stop before turning as far as possible. Avoid braking in turning which may cause slide of one or two wheels and reduce control over the motorcycle.
- The ability to brake in turning and emergencies is an important riding skill. We suggest taking a safety basic experience training course for motorcycle drivers to obtain these skills.
- When riding in wet or rainy conditions or on soft ground, the maneuverability and braking capacity of motorcycle will be weakened. In this case, all your actions shall be slowed down; sudden acceleration, braking or turning may lead to loss of control over the motorcycle. For your safety, please be careful in braking, accelerating or turning.
- On long steep road section, intermittent use of brake and continuous braking may overheat the brake and reduce its working effect.
- When riding, if your foot rests on the brake or your hand rests on the brake lever, the stop lamp may be turned on by mistake, giving wrong signal to other drivers; this may also overheat the brake and reduce its working effect.

## Closing the Riding System

The methods of turning off the riding system are as follows:

1. Lay down the side stand, the "READY" on the instrument will not light up, the electrical system of the whole vehicle is in standby state, and the vehicle will not move forward after the throttle is turned.
2. If the vehicle is started with a mechanical key or with a coordination of electronic key and front lock, directly turn the front lock key to position 2 and the electrical system of the whole vehicle is turned off.

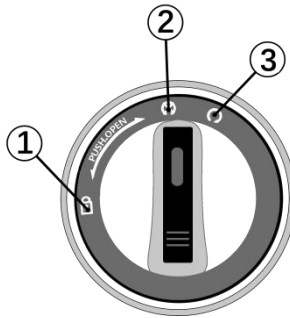

3. If started by remote controller, press the lock key 3 on the controller and the whole electric system will be turned off.

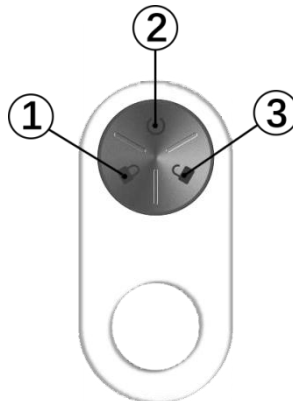

4. If the vehicle is started by sliding the screen, then swipe the screen to the left, the electrical system of the whole vehicle will be turned off.

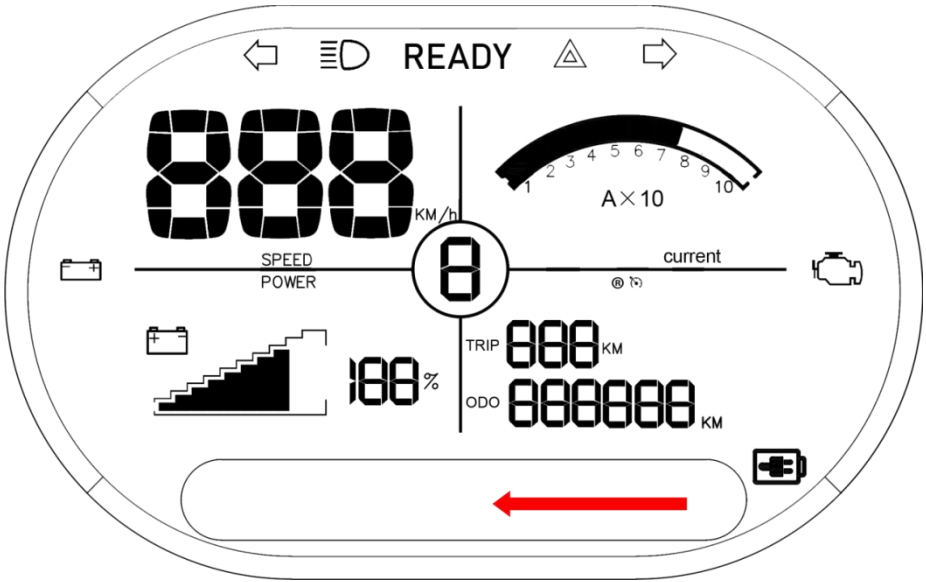

## Product Manual

Due to the continuous improvement of our products, design changes and other reasons, the product described in this manual may be inconsistent with the product you purchased. Please refer to the actual products.

## Maintenance Plan

When a new motorcycle reaches a range of 1000 km or service life of two months (whichever comes first), the first inspection and maintenance shall be carried out in the service center.

Regular inspection and maintenance for each 3000km or 6 months

(whichever comes first) are recommended in the service center.

### Service Tips

Please turn off the vehicle power before cleaning the vehicle.

Do not flush with strong water jet directly which may cause fault to mechanical components by damp.

Inspection Item	Mileage count/time interval (whichever comes first)							
	3,000mi/500km or 1 month	6,000mi/1,000km or 2 months	3,000mi/4,800km or 6 months	6,000mi/9,600km or 12 months	9,000mi/14,400km or 18 months	12,000mi/19,300km or 24 months	15,000mi/24,100km or 30 months	18,000mi/28,900km or 36 months
Throttle operation Turning the throttle to ensure stable riding and loose the throttle with a "click" sound to recover 0% starting position	√	√	√	√	√	√	√	√
Transmission chain Check the tightness of the chain (*) Adjust and lubricate the chain	Clean EK3 after riding it for 300 miles in wet or dirty places, and replace the chain if necessary.							
Front brake Inspection operation, liquid level and leakage	√	√	√	√	√	√	√	√
Rear brake Inspection operation, liquid level and leakage	√	√	√	√	√	√	√	√
Front and rear braking systems Check the thickness of hose and bolts	√	√	√	√	√	√	√	√
Replace the brake fluid (**)				√		√		√

Front and rear brake light switches Inspection operation	√	√	√	√	√	√	√	√
Signal lights and headlights Inspection operation(*)	√	√	√	√	√	√	√	√
Side stand Inspection operation	√	√	√	√	√	√	√	√
Front shock absorber, front fork Inspection operation and seek leakage	√	√	√	√	√	√	√	√
Replace gear oil GL-5 85W/90 (*)		√	√	√	√	√	√	√
Fasteners (*) Check all fasteners and connectors of the chassis Reinforce all fasteners and connectors and adjust them as needed	√	√	√	√	√	√	√	√
Tire Check the tire pressure Check the tread depth. If the tread depth of the front tire is less than 1.5mm and the tread depth of the rear tire is less than 2.0mm, please replace the tires Check the aging condition	√	√	√	√	√	√	√	√
Rim Check for roundness or dents Replace the rim if necessary (**)	√	√	√	√	√	√	√	√
Steering bearing (**) Check the looseness of the bearing	√	√	√	√	√	√	√	√

Check the battery Find the visible damage or dents	√	√	√	√	√	√	√	√
Motor (* *) Inspection operation Check the cable for cracks or damage	√	√	√	√	√	√	√	√
<p>(* ) Unless you have the appropriate tools, service data and mechanical qualifications, otherwise, the vehicle shall be inspected by your HORWIN authorized dealer. (* *) For safety reasons, we recommend that these items can only be provided by your authorized HORWIN dealer.</p>								

## Troubleshooting

Troubleshooting of the Whole Vehicle		
Phenomenon	Cause	Treatment Method
Turn on the power switch and the vehicle has no power output	The vehicle is not powered	<p>Treatment Method</p> <p>1 Check whether the connectors of the battery are plugged on the vehicle properly</p> <p>2 The battery is under undervoltage condition, please charge the battery</p>

<p>Turn on the power switch, rotate the speed regulating handle, the motor is not started</p>	<ol style="list-style-type: none"> <li>1. The vehicle is in a braking state</li> <li>2. The vehicle is in a parking state</li> <li>3. The side stand is not retracted</li> <li>4. The start switch has failure</li> <li>5. The braking handle is not reset</li> </ol>	<ol style="list-style-type: none"> <li>1. Check whether the vehicle is in a braking state</li> <li>2. Retract the side stand</li> <li>3. Contact the after sales service personnel and check the automatic switch</li> </ol>
---	---	--

Phenomenon	Cause	Treatment Method
The endurance mileage is insufficient	<ol style="list-style-type: none"> <li>1. The battery is not fully charged</li> <li>2. The tire pressure is insufficient</li> <li>3. The vehicle is braked and started frequently and the vehicle is overloaded</li> <li>4. The battery is aged or normally attenuated</li> <li>5. The environmental temperature is too low and the battery capacity is reduced</li> </ol>	<ol style="list-style-type: none"> <li>1. Check the charger for damage</li> <li>2. Check the tire pressure before each use</li> <li>3. Develop good driving habits</li> <li>4. Replace the battery</li> <li>5. Normal phenomenon</li> </ol>
The battery cannot be charged	<ol style="list-style-type: none"> <li>1. The charger plug is not inserted into the socket properly</li> <li>2. The battery temperature is excessively low</li> <li>3. The battery temperature is excessively high</li> </ol>	<ol style="list-style-type: none"> <li>1. Check whether the plug is loose</li> <li>2. Wait until the battery temperature is the charging temperature</li> <li>3. Contact the after-sales personnel to check the battery status</li> </ol>
The mobile phone cannot be charged through the USB interface	<ol style="list-style-type: none"> <li>1. USB cable plug is not plugged in the interface properly</li> <li>2. USB cable fails to meet the mobile standard</li> <li>3. The USB charger is damaged</li> </ol>	<ol style="list-style-type: none"> <li>1. Check whether the cable plug is plugged in the USB interface properly</li> <li>2. Please buy a connecting cable that meets the mobile standard</li> <li>3. Contact the after-sales service personnel. Replace damaged parts</li> </ol>

## OBd code

<b>Fault code</b>	<b>Fault</b>	<b>Treatment Method</b>
P0120	Speed control throttle fault 1, the voltage of the throttle is out of range	Contact the after sales service or dealer
P0C01	Overcurrent fault of the controller, the average current of the controller exceeds the limit value	Contact the after sales service or dealer
P0AED	The temperature of the controller temperature sensor is out of range, the controller is overheated	Contact the after sales service or dealer
P0A3F	The motor has the Hall fault, and the Hall signal input of the motor is abnormal	Contact the after sales service or dealer
U0110	The communication of the controller is delayed, the controller has no communication or the communication is suspended	Contact the after sales service or dealer
P0A2F	The motor is subject to overheat protection, and the motor temperature exceeds the maximum limit	Contact the after sales service or dealer
P0C79	The controller has overvoltage fault, and the input voltage of the controller exceeds the limit value	Contact the after sales service or dealer

## Controller

<b>Protection Characteristics of Controller System</b>		<b>Flashing Frequency of LED</b>
Overvoltage protection	The battery voltage is higher than the set value	1
Undervoltage protection	The battery voltage is lower than the set value	2
Motor Overcurrent Protection	The phase line of the motor is short-circuited.	3
Stalling Protection	The stalling time of the motor exceeds the set value	4
HALL Protection	The input of HALL is abnormal.	5
Power tube protection	After the self test, the power tube is abnormal.	6
Open-phase protection	One phase line of the motor is disconnected.	7
Self-test error protection	The abnormality is discovered when the system is subject to POST	10
Controller overheat protection	The operating temperature of the controller is higher than the set value of the system.	11
Throttle overspeed protection	The input of the throttle is abnormal	12
Motor overheat protection	The temperature of the motor is higher than the set value.	13
After being powered on, the throttle is not reset	When the controller is powered on, the throttle is not in a loose state.	14
The controller is braked	The controller is in a braking state.	15

## **Cleaning of the Vehicle**

- Please mix tap water and neutral detergent to scrub the vehicle. After scrubbing the vehicle, wipe the surface with a soft cloth.
- Please do not directly flush both sides and inside of the instrument with a high-pressure water gun. Electronic components, such as charging interface and controller, are in the side cover above the footboard, so please do not flush them directly, so as to avoid the water damage.

## **Safekeeping Method of Vehicle**

- Please store the vehicle in a flat, solid, well ventilated and dry place. Please avoid the vehicle from being exposed to the sun and rain, so as to reduce the damage or aging of parts. When storing the vehicle for a long time, please refer to the contents about the battery in this manual.
- When the vehicle is used again after being stored for a long time, the battery should be fully charged;

# Basic Parameter

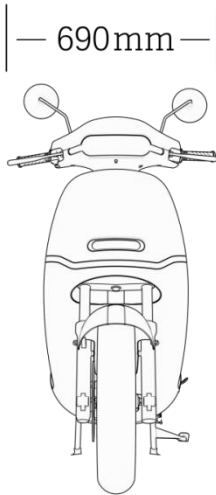
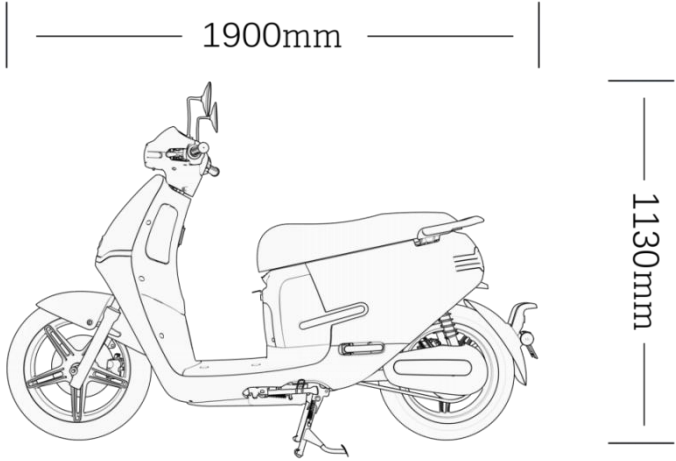

<b>Item</b>	<b>Parameters</b>
Motor type	DC motor
Rated power	3.5KW
Maximum power	6.2KW
Maximum Speed	95km/h
Range (AT 45 KM/H WITH	100KM
Battery capacity	40AH
Battery type	Lithium battery
Instrument	LCD
Lamp system of the vehicle	LED
Brake system	CBS oil brake
Battery voltage	72V
Standard charging current	10A
Charging time	4H
Wheelbase	1320mm
Minimum ground clearance	125mm
Steering angle	44°
Front hub	MT2.5×14
Rear hub	MT3.0×13
Front tire size	100/80-14
Rear tire size	110/70-13
Front braking method	Oil brake
Rear braking method	Oil brake
Length of vehicle	1900mm
Width	690mm
Height	1130mm
Seat height	780mm
Net weight without battery	95KG
Technically permissible maximum laden mass	284KG

## Warranty Registration Form

Year:		Model:	
VIN No.:			
Motor No.:			
Date of purchase:			
User name:			
User Address:			
User Contact number:			

Note: This form shall be completed by the customer and shall be filed by the dealer.

### Policy of Warranty

Thank you very much for purchasing EK3 electric motorcycle produced by HORWIN. In order to provide users with comprehensive service guarantee, according to relevant laws and regulations and relevant national regulations on after-sales service, and in combination with product characteristics, the specific provisions about the after-sales service are as follows:

The core components (frame, motor and battery) of the whole vehicle are guaranteed for two years or a total mileage of 20,000 kilometers,

whichever comes first, and the Standard Instructions on Three Guarantees is the implementation basis.

Within the warranty period, HORWIN service provider will freely provide repair service and replacement service. If the maintenance is beyond the service period or scope of "Three Guarantees", HORWIN service provider will provide paid services according to local market conditions and maintenance prices.

For the sold products, the warranty period starts from the date of signature for express delivery.

### Warranty Standards of Spare Parts

Item	Spare Parts	Warranty Scope	Warranty Period
Vehicle Body	Frame, handle	When the vehicle is used within the normal load and road range, there is natural snap, desoldering or fracture on the vehicle	24 months
	Front/rear hub, front/rear shock absorber, chain, chain wheel, tire, steering column	When the vehicle is used within the normal load and road range, there is natural snap, desoldering or fracture on the vehicle (*due to quality problem, the tire is bulged or cracked)	12 months
	Saddle, battery charging interface, single and double stands, rear pedal assembly and side stand induction switch		6 months

Item	Spare Parts	Warranty Scope	Warranty Period
Vehicle Body	Painted plastic parts, electroplated parts, handrails	The painted surface is seriously chipped, faded, blistered and cracked	6 months
	Front brake assembly, rear brake assembly and disc brake		9 months
Electrical parts	Non-fast charger (accessory delivered with the vehicle)	Due to product reasons, the performance failure or quality problem occurs and cannot be repaired	24 months
	Fast charger		12 months
	Controller, display instrument. Handle, main cable, flasher, horn and remote alarm. Electric door lock (including auxiliary lock and key) DC-DC converter and combination switch		
	Headlight assembly, rear taillights, side lamps and turn signals		
Motor	Motor	Phase loss, burning, demagnetization and other quality problems that are not caused by the external forces	24 months or 20,000 kilometers (whichever comes first)

Item	Spare Parts	Warranty Scope	Warranty Period
Battery	Battery	<p>In the specified use environment, the lithium battery is used after being charged and is not impacted by external force.(The range of the environment temperature at which the lithium battery can be charged is 0°C~35°C, and the range of the environment temperature at which the lithium battery can be used is -10°C~45°C. In low temperature environment, the capacity of lithium battery will be deteriorated at different degrees. Specifically, the available capacity is 70% at -10°C, 85% at 0°C and 100% at 25°C) If the battery voltage is abnormal and cannot be charged, and the discharge meter detects that the capacity is less than 70%, we will provide three-guarantee service to users. (If the battery cannot be cycled, the three-guarantee period for the replaced battery is calculated as the remaining three-guarantee period of the original battery)</p>	<p>24 months or 20,000 kilometers (whichever comes first)</p>

## **Instructions to other items not covered by warranty standard**

- Based on the above table, if the items are beyond the time limit and scope of three guarantees, they are beyond the scope of three-guarantee service.
- Other parts not included in the above table, such as brake shoe, brake oil, power socket, cable, USB, PP and appearance parts, are vulnerable and consumable parts and cannot enjoy the "Three-Guarantee" service.
- Normal maintenance services, including but not limited to: replacing gear oil, checking tires, checking brakes, adjusting brakes, changing brake fluid, checking electrical system, checking chain tension, adjusting chain tension, replacing chains and checking battery packs, are not within the scope of "Three Guarantees".
- Advertising promotion items, gift items, sound volume, touch-sense items and other sensory & cognitive items.
- Damage caused by smoke, earthquake, typhoon, flood, fire, lightning strike, chemical corrosion and other force majeure factors.
- If the vehicle is not repaired by the service provider, the parts are modified, decomposed and damaged by the user, other parts are damaged due to use of non-original parts, and the circuit and configuration are modified by the user without authorization, the user will not enjoy the Three-Guarantee service.
- Damage caused by human factors such as crash, falling, overspeed, overload, unauthorized modification, failure to use original parts, failure to operate the vehicle according to operating instructions.

- There is no invoice, warranty card or bill or the bill is inconsistent with the card.
- If the parts such as controller and charger are provided with trademarks or seals, and the trademarks or seals are torn artificially, these parts will not be guaranteed.
- The user fails to use and maintain the battery normally, the storage time exceeded 2 months (the battery is plugged into the vehicle and stored for more than 15 days; the initial power is less than 50% and the battery is stored separately for more than 2 months), and the battery is not charged in time, therefore the battery feeding and undervoltage are caused and the faults are irreparable.

## Repair & Maintenance Records

In order to enhance your warranty experience, please be sure to repair and maintain your vehicle at our authorized dealers. And please record in the form below and stamp the dealer's seal.

Model:	Frame No.:	Motor No.:
The 1st service Date: Range:		Dealer's stamp
The 2nd service Date: Range:		Dealer's stamp
The 3rd service Date: Range:		Dealer's stamp
The 4th service Date: Range:		Dealer's stamp
The 5th service Date: Range:		Dealer's stamp
The 6th service Date: Range:		Dealer's stamp

<p>The 7th service Date: Range:</p>	<p>Dealer's stamp</p>
<p>The 8th service Date: Range:</p>	<p>Dealer's stamp</p>
<p>The 9th service Date: Range:</p>	<p>Dealer's stamp</p>
<p>The 10th service Date: Range:</p>	<p>Dealer's stamp</p>
<p>The 11th service Date: Range:</p>	<p>Dealer's stamp</p>
<p>The 12th service Date: Range:</p>	<p>Dealer's stamp</p>
<p>The 13th service Date: Range:</p>	<p>Dealer's stamp</p>

The 14th service Date: Range:	Dealer's stamp
The 15th service Date: Range:	Dealer's stamp
The 16th service Date: Range:	Dealer's stamp
The 17th service Date: Range:	Dealer's stamp
The 18th service Date: Range:	Dealer's stamp
The 19th service Date: Range:	Dealer's stamp
The 20th service Date: Range:	Dealer's stamp



**HORWIN Headquater**

Building No. 33-1&3 | Hengsheng Science & Technology Park  
Beitanghe Rd | Tianning district | Changzhou | Jiangsu  
phone.: +86 519 80585808 | email: horwin@horwinglobal.com

**European Headquater**

Kammersdorf 173 | A-2033 Kammersdorf  
phone.: +43 2953 2325 | email: info@horwin.eu  
www.horwin.eu

**[www.horwinglobal.com](http://www.horwinglobal.com)**

